

# Tarasola®

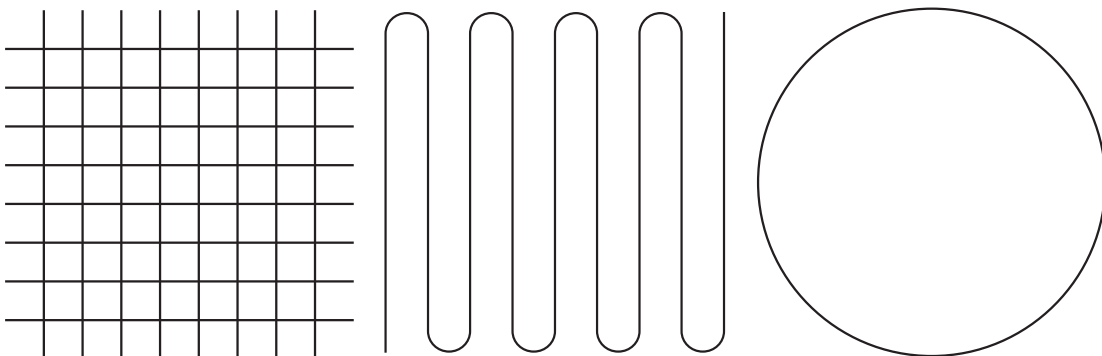

## Tarasola Carport Tarasola Fix

FR IT









# Table des matières

## Indice

- 02 **Description de produit** | Descrizione del prodotto
- 04 **Galerie des photos** | Galleria
- 20 **Caractéristiques principales** | Specifiche
- 21 **Sections** | Sezioni
- 22 **Dimension maximale d'un module**  
| Dimensioni massimali di un modulo singolo
- 25 **Station de recharge des voitures JUICEBOX PRO**  
| Stazione di ricarica per auto JUICEBOX PRO
- 26 **Panneaux photovoltaïques** | Pannelli fotovoltaici
- 28 **Closure latérale** | Chiusure laterali
- 29 **Accessoires** | Accessori
- 30 **Couleurs** | Colori
- 32 **Certificats** | Certificazioni
- 32 **Prix** | Premiazioni

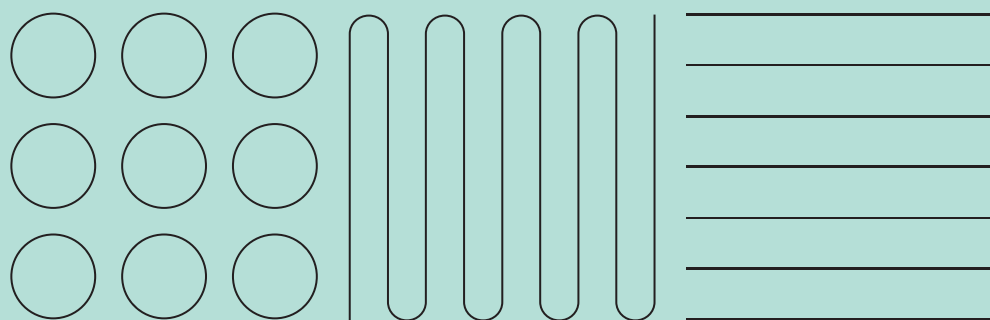

# Description de produit

## Descrizione del prodotto

FR

**Tarasola Carport** est un abri de voiture moderne. C'est un toit solide et fixe qui protège la voiture du soleil, de la pluie, du vent et de la neige. La forme minimaliste, l'apparence de la finition, sans éléments visibles et le choix des couleurs permettent d'utiliser Carport dans n'importe quel environnement.

### **Tarasola Carport = Tarasola Fixe**

La structure Carport peut être utilisée avec succès comme toiture de terrasse standard. Dans cette option, nous recommandons d'ajouter un toit inférieur sous la forme d'un tissu esthétique et d'équiper la structure d'un éclairage ruban LED et de radiateurs. Si vous souhaitez vous protéger ainsi que vos meubles et accessoires, il vaut la peine de choisir des brise-vues orientables, des stores ZIP ou des vitrages. Vous gagnerez un espace fonctionnel pour passer du temps à tout moment de la journée ou même de l'année.

IT

**Tarasola Carport** è un garage moderno. È una copertura solida e fissa che protegge l'auto dal sole, dalla pioggia, dal vento e dalla neve. La forma minimalista, la finitura estetica, l'assenza di elementi di fissaggio visibili e la scelta dei colori consentono di adattare il Carport a qualsiasi ambiente.

### **Tarasola Carport = Tarasola Fix**

Il design del Carport può rappresentare con successo la copertura standard della terrazza. In questa opzione si consiglia di aggiungere il tetto inferiore sotto forma di tessuto estetico e di dotare la struttura di illuminazione a LED Strip e radiatori. Se si desidera proteggere se stessi, mobili e accessori vale la pena scegliere una copertura laterale come frangisoli scorrevoli, tende a rullo ZIP o vetri. Otterrai uno spazio funzionale per trascorrere il tuo tempo in qualsiasi momento della giornata o anche dell'anno.

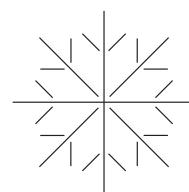
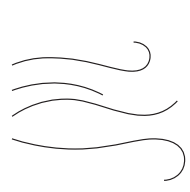
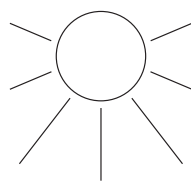
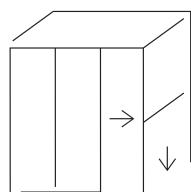

## Toit tôle trapézoïdale avec les panneaux photovoltaïques

### Tetto in lamiera trapezoidale con pannelli fotovoltaici

Une toiture fixe donne la possibilité d'installer des panneaux photovoltaïques et d'utiliser l'électricité qui en résulte pour alimenter des appareils électroménagers ou pour recharger une voiture électrique.

Un tetto fisso offre la possibilità di installare pannelli fotovoltaici e di utilizzare l'elettricità che ne deriva per alimentare elettrodomestici o per ricaricare un'auto elettrica.



**Toit avec les panneaux photovoltaïques**

Tetto in lamiera trapezoidale con pannelli fotovoltaici



**Toit sans panneaux photovoltaïques**

Tetto in lamiera trapezoidale senza pannelli fotovoltaici

## Toiture inférieure – tissu en option

### Tetto inferiore - tessuto come opzione

En option, vous pouvez commander un toit inférieur qui couvrira la tôle visible par le bas. Ensuite, le bas du toit est en tissu esthétique avec des raidisseurs dans lesquels un éclairage LED peut être monté.

Opzionalmente, è possibile ordinare un tetto inferiore, che coprirà il foglio di lamiera visibile da sotto. Quindi la parte inferiore del tetto è realizzata in tessuto estetico con rompitratte in cui è possibile montare l'illuminazione a LED.



**Toit avec le tissu inférieur**

Tetto con tessuto



**Toit sans tissu**

Tetto senza tessuto

# Galerie des photos Galleria

---

Tarasola  
Carport

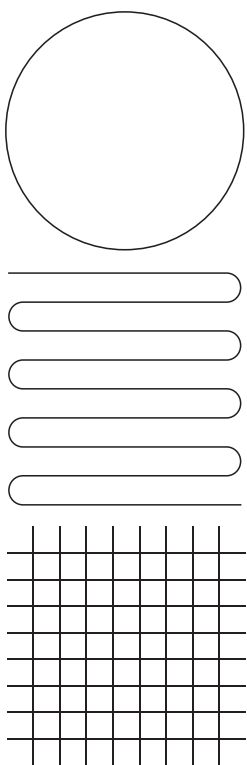









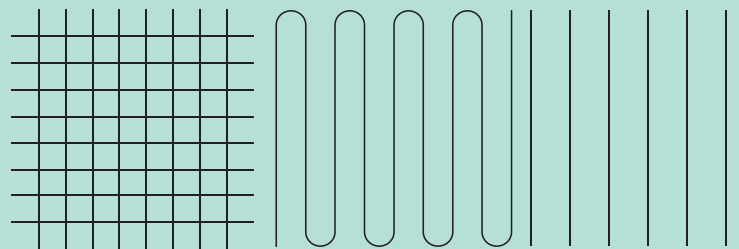
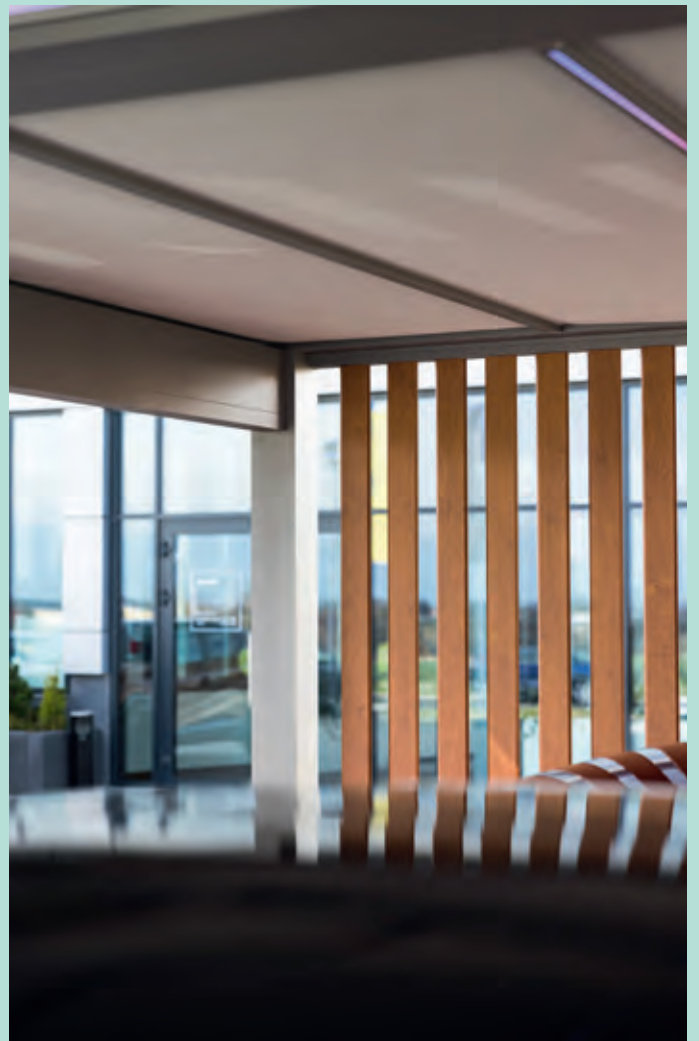





















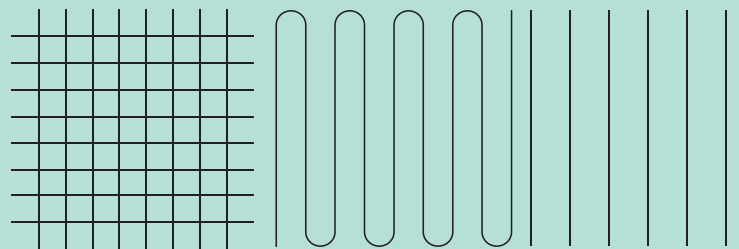





---

## Tarasola Fix





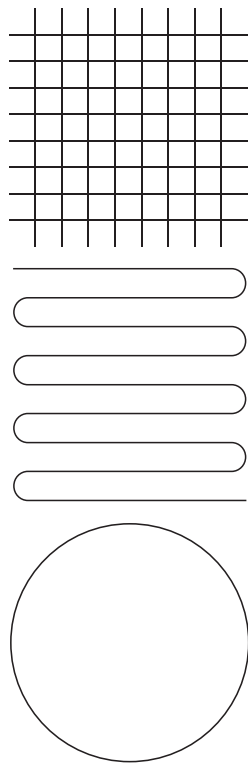



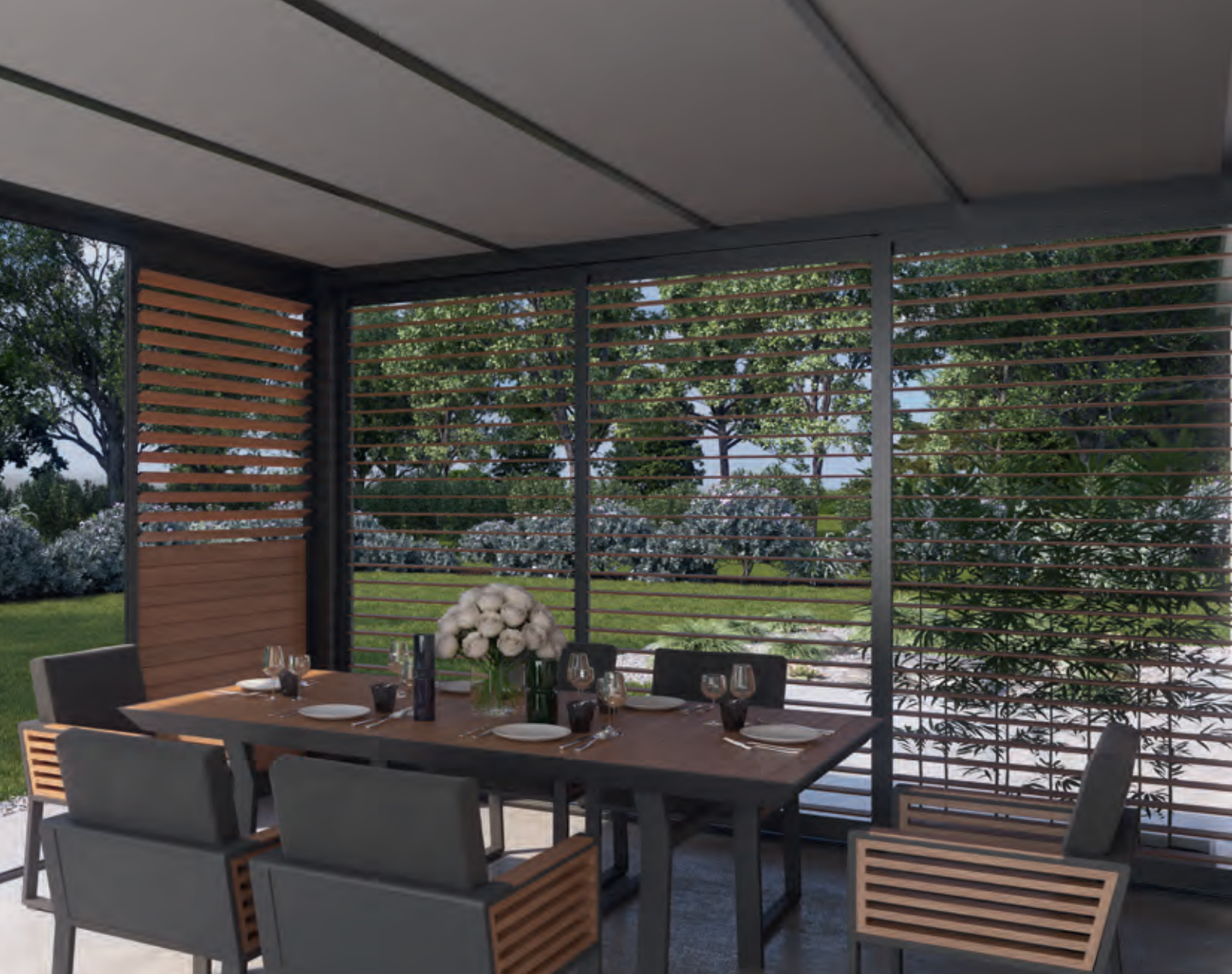









# Caractéristiques principales

## Specifiche



FR

La construction **en aluminium** extrudé revêtu de peinture en poudre, toit en **tôle trapézoïdale**

---

**Système d'évacuation des eaux** en version standard

---

Possibilité de monter **des panneaux photovoltaïques** sur le toit

---

Possibilité **de jonction modulaire**

---

Produit résistant à la force du vent jusqu'à **120 km/h**

---

Résistance à la charge de neige **72-300 kg/m<sup>2</sup>**

IT

Struttura in **alluminio** estruso verniciato a polvere, tetto in **lamiera trapezoidale**

---

**Sistema di drenaggio** dell'acqua di serie

---

Possibilità di installare **pannelli fotovoltaici** sul tetto

---

Possibilità **di collegamento modulare**

---

Resistenza al vento fino a **120 km/h**

---

Resistenza al carico di neve **72-300 kg/m<sup>2</sup>**



# Sections | Sezioni

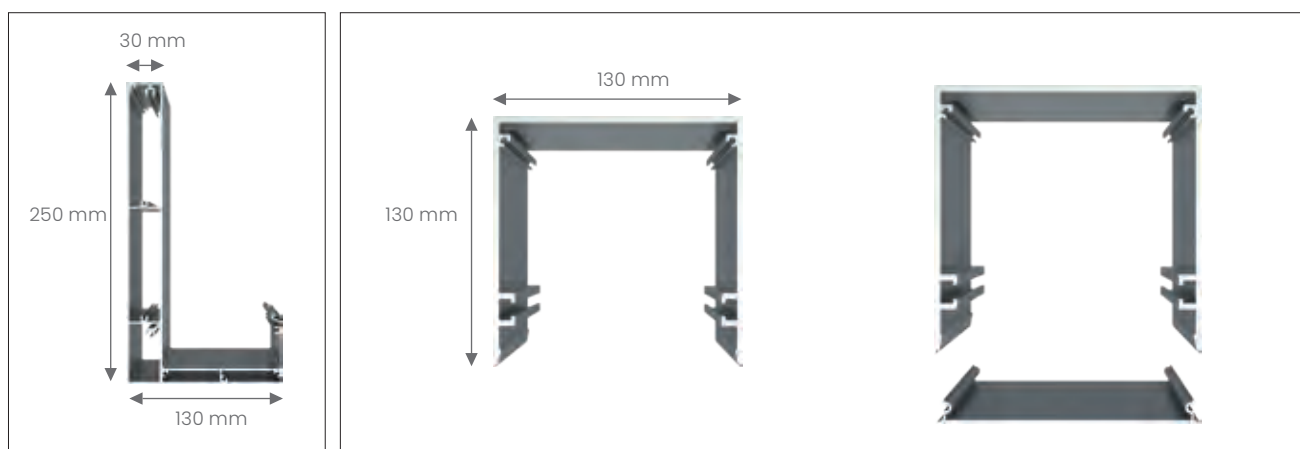

**Profilé de construction**

Profilo costruttivo

**Profilé de support ouvert**

Profilo di supporto apribile

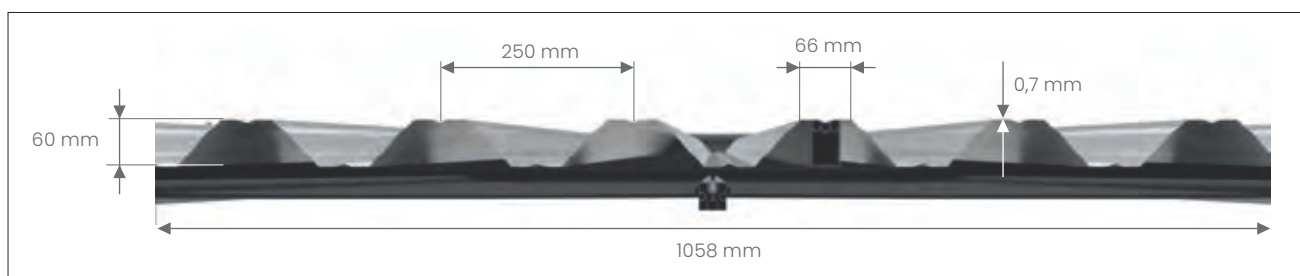

**Vue de coupe de la tôle a plis en trapèze T60P (mm) | Sezione trasversale della lamiera trapezoidale T60P (mm)**

# Systeme d'évacuation des eaux Sistema di drenaggio

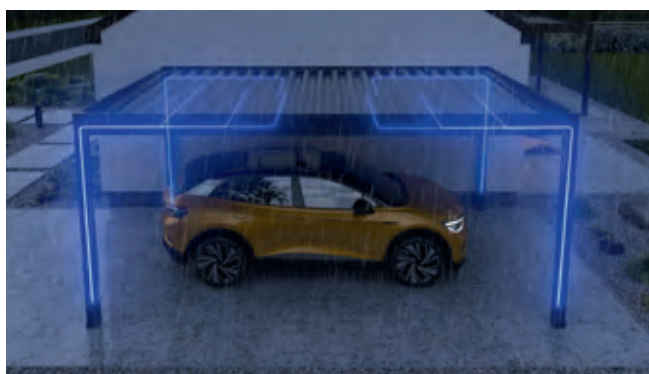

# Dimension maximale d'un module

## Dimensioni massimali di un modulo singolo

**À station unique** | A posto singolo



PAVILON	GARDENA	TENDE
Avec châssis   Con cancello	Avec châssis   Con cancello	



## À deux stations | A due posti



PAVILON

GARDENA

TENDE



Avec châssis | Con cancello



Avec châssis | Con cancello



## À station unique, modulaire | A posto singolo



PAVILON	GARDENA	TENDE
		

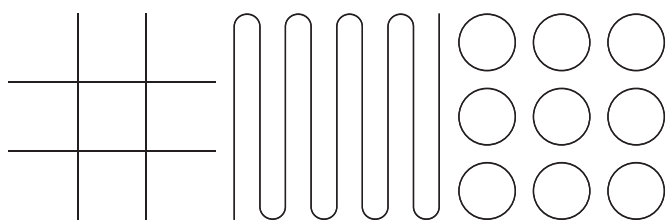



# Station de recharge des voitures JUICEBOX PRO

Stazione di ricarica per auto JUICEBOX PRO



FR

**JuiceBox Pro** Disponible en niveau de puissance 22 kW, 32A, triphasé. Il est doté d'une fonction Demand Limitation Pro qui permet de charger à la puissance maximale disponible sans la dépasser.

IT

**JuiceBox Pro** Disponibile nel livello di potenza 22 kW, 32A, trifase. Ha la funzione Demand Limitation Pro, che consente di caricare con la massima potenza disponibile senza superarla.

# Panneaux photovoltaïques

## Pannelli fotovoltaici



FR

Tarasola Carport est une toiture créée sur mesure. Les panneaux photovoltaïques qui ont leurs propres dimensions fixes, définissent un certain cadre, mais la toiture en tôle trapézoïdale située en dessous permet d'adapter la taille de la toiture aux besoins de l'investisseur. En fonction des dimensions choisies de la structure, les paquets de panneaux appropriés sont sélectionnés.

IT

Terrasola Carport è una copertura su misura. I pannelli fotovoltaici, che hanno le loro dimensioni fisse, definiscono una certa struttura, ma il tetto in lamiera trapezoidale sottostante consente di adattare le dimensioni del tetto alle esigenze dell'investitore. A seconda della dimensione della costruzione scelta, vengono selezionati i pacchetti di pannelli appropriati.



## Exemples de paquets | Ad esempio

### PAQUET 1 | PACCHETTO 1

À station unique | A posto singolo

Largeur   Larghezza	400 cm
Avancée   Sporgenza	590 cm
Panneaux   Pannello	10 pezzi   pcs. TIGER NEO (TYP N 54HL4-B 400-420 W)
Puissance totale   Potenza totale	4200 W

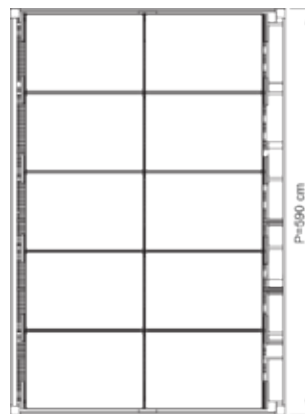
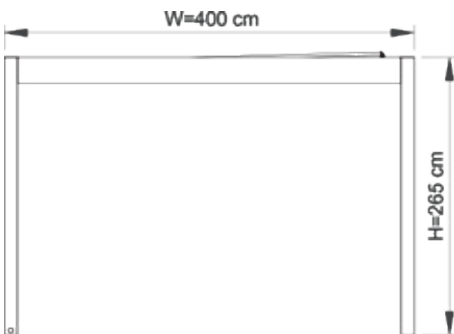

### PAQUET 2 | PACCHETTO 2

À deux stations | A due posti

Largeur   Larghezza	530-600 cm
Avancée   Sporgenza	540-590 cm
Panneaux   Pannello	12 pezzi   pcs. TIGER NEO (TYP N 54HL4-B 400-420 W)
Puissance totale   Potenza totale	5040 W

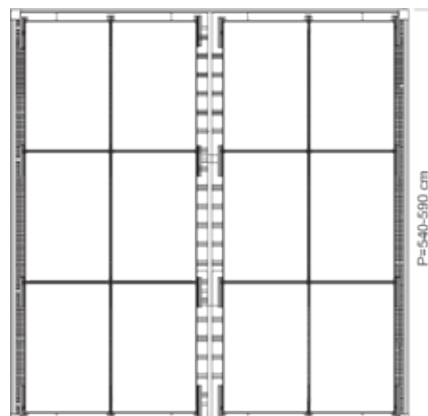
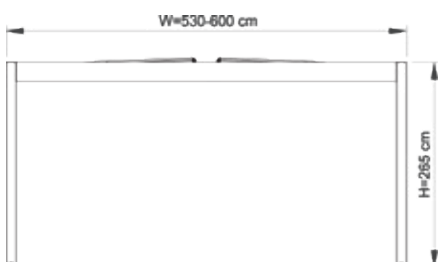

# Closure latérale

## Chiusure laterali

Store ZIP

Tende a rullo ZIP

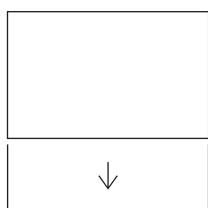

Parois vitrées

Vetrare scorrevoli

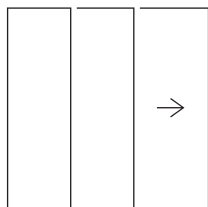

Shutters

Shutters

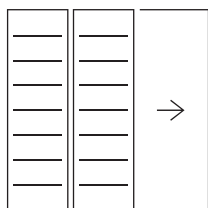



# Accessoires

## Accessori

Éclairage

Illuminazione

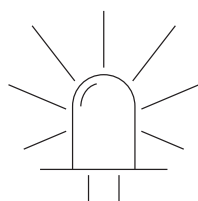

Toit inférieur avec le tissu | Tetto inferiore con tessuto

LED Spot



LED Strip



Toit inférieur sans tissu (tôle uniquement) | Tetto inferiore senza tessuto (solo lamiera)

LED Strip



Radiateurs infrarouges

Radiatori di calore

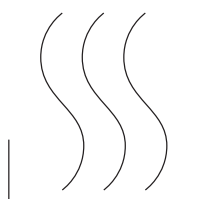

# Couleurs | Colori

## Construction | Costruzione

### STANDARD



9010 ST

blanc crème

bianco crema



9007 ST

gris aluminium

grigio alluminio

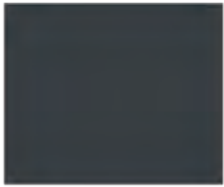

7016 ST

anthracite

antracite

### SUPPLÉMENTAIRES | AGGIUNTIVI



Couleur  
de la palette RAL

Qualsiasi colore RAL



Peinture  
imitation bois

Simil Legno

## Toit en tôle trapézoïdale | Tetto in lamiera trapezoidale

### STANDARD



9010

blanc crème

bianco crema



9007

gris aluminium

grigio alluminio



7016

anthracite

antracite



8004

brun

marrone

### SUPPLÉMENTAIRES | AGGIUNTIVI



Couleur  
de la palette RAL

Qualsiasi colore RAL













Peinture  
imitation bois

Simil Legno



Opatex – Unterer Stoffdach | Opatex Fabric – bottom roof

	blanc/blanc _____ bianco/bianco		anthracite/crème _____ antracite/crema
	gris/gris clair _____ grigio/grigio chiaro		gris-marron/crème _____ talpa/crema
	crème/crème _____ crema/crema		vert/crème _____ verde/crema
	gris/crème _____ grigio/crema		anthracite/anthracite _____ antracite/antracite
	bordeaux/crème _____ bordeaux/crema		noir/noir _____ nero/nero

SUPLÉMENTAIRES | AGGIUNTIVI

Veozip | Serge 600 / Copaco / Aeroflex | Soltis W 96 | Serge 600 SOLAR



# Certificats | Certificazioni

Calcul des structures en alliages d'aluminium	Progettazione di strutture in alluminio	EUROCODE 9: EN 1999
Tôle trapézoïdale	Lamiera trapezoidale	PN-EN 14782:2008
Stores extérieurs. Exigences de performance, y compris la sécurité	Tende esterne. Requisiti prestazionali inclusa la sicurezza.	PN-EN 13561 + A1/2010
Régulation des produits de construction	Regolamento Prodotti da Costruzione	CPR 305/2011
Éclairage ruban LED	Illuminazione LED	EN 62031 :2008
Peinture en poudre	Verniciatura a polvere	QUALICOAT
Résistance maximale au vent	Massima resistenza al vento	120 km/h
Résistance à la charge de neige	Resistenza al carico di neve	72-300 kg/m2

# Prix | Premiazioni

 <p>2011-2021 LEADER DES CONSOMMATEURS DE LA DÉCENNIE</p> <hr/> <p>Leader dei Consumatori del Decennio</p>	 <p>2020 INNOWATORY WPROST INNOVATION DANS LA CATÉGORIE DESIGN</p> <hr/> <p>Innovazione nella categoria DESIGN</p>	 <p>2020 GAZELLES DES AFFAIRES</p> <hr/> <p>Gazzelle d'affari</p>
---	---	--



# Contact

## Contatti

---

FR +48 780 038 410 [export@tarasola.com](mailto:export@tarasola.com)

IT +48 573 250 586 [export@tarasola.com](mailto:export@tarasola.com)

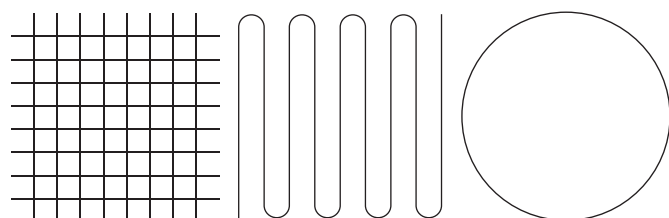

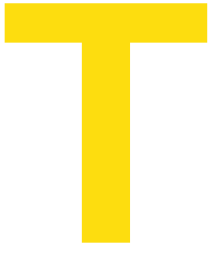

**Tarasola.com**

